

User Manual



## GUITAR LINK UCG102

The Ultimate Guitar-to-USB Interface for Recording and Jamming with your PC/Mac or iOS device

**МУЗЦЕНТР**  
МУЗЫКАЛЬНОЕ ОБОРУДОВАНИЕ  
<https://muzcentre.ru>



behringer

## Table of Contents

<b>Important Safety Instructions .....</b>	<b>3</b>
<b>Legal Disclaimer .....</b>	<b>4</b>
<b>Limited Warranty .....</b>	<b>4</b>
<b>1. Introduction .....</b>	<b>6</b>
<b>2. Controls and Connections .....</b>	<b>7</b>
<b>3. Application Example .....</b>	<b>8</b>
<b>4. Audio Connections .....</b>	<b>9</b>
<b>5. Specifications .....</b>	<b>11</b>

**EN Important Safety Instructions**

Terminals marked with this symbol carry electrical current of sufficient magnitude to constitute risk of electric shock.

Use only high-quality professional speaker cables with ¼" TS or twist-locking plugs pre-installed. All other installation or modification should be performed only by qualified personnel.



This symbol, wherever it appears, alerts you to the presence of uninsulated dangerous voltage inside the enclosure - voltage that may be sufficient to constitute a risk of shock.



This symbol, wherever it appears, alerts you to important operating and maintenance instructions in the accompanying literature. Please read the manual.

**Caution**

To reduce the risk of electric shock, do not remove the top cover (or the rear section). No user serviceable parts inside. Refer servicing to qualified personnel.

**Caution**

To reduce the risk of fire or electric shock, do not expose this appliance to rain and moisture. The apparatus shall not be exposed to dripping or splashing liquids and no objects filled with liquids, such as vases, shall be placed on the apparatus.

**Caution**

These service instructions are for use by qualified service personnel only. To reduce the risk of electric shock do not perform any servicing other than that contained in the operation instructions. Repairs have to be performed by qualified service personnel.

1. Read these instructions.
2. Keep these instructions.
3. Heed all warnings.
4. Follow all instructions.
5. Do not use this apparatus near water.
6. Clean only with dry cloth.
7. Do not block any ventilation openings. Install in accordance with the manufacturer's instructions.
8. Do not install near any heat sources such as radiators, heat registers, stoves, or other apparatus (including amplifiers) that produce heat.
9. Do not defeat the safety purpose of the polarized or grounding-type plug. A polarized plug has two blades with one wider than the other. A grounding-type plug has two blades and a third grounding prong. The wide blade or the third prong are provided for your safety. If the provided plug does not fit into your outlet, consult an electrician for replacement of the obsolete outlet.
10. Protect the power cord from being walked on or pinched particularly at plugs, convenience receptacles, and the point where they exit from the apparatus.

**11.** Use only attachments/accessories specified by the manufacturer.



**12.** Use only with the cart, stand, tripod, bracket, or table specified by the manufacturer, or sold with the apparatus. When a cart is used,

use caution when moving the cart/apparatus combination to avoid injury from tip-over.

**13.** Unplug this apparatus during lightning storms or when unused for long periods of time.

**14.** Refer all servicing to qualified service personnel. Servicing is required when the apparatus has been damaged in any way, such as power supply cord or plug is damaged, liquid has been spilled or objects have fallen into the apparatus, the apparatus has been exposed to rain or moisture, does not operate normally, or has been dropped.

**15.** The apparatus shall be connected to a MAINS socket outlet with a protective earthing connection.

**16.** Where the MAINS plug or an appliance coupler is used as the disconnect device, the disconnect device shall remain readily operable.



**17.** Correct disposal of this product: This symbol indicates that this product must not be disposed of with household waste, according to the WEEE

Directive (2012/19/EU) and your national law. This product should be taken to a collection center licensed for the recycling of waste electrical and electronic equipment (EEE). The mishandling of this type of waste could have a possible negative impact on the environment and human health due to potentially hazardous substances that are generally associated with EEE. At the same time, your cooperation in the correct disposal of this product will contribute to the efficient use of natural resources. For more information about where you can take your waste equipment for recycling, please contact your local city office, or your household waste collection service.

**18.** Do not install in a confined space, such as a book case or similar unit.

**19.** Do not place naked flame sources, such as lighted candles, on the apparatus.

**20.** Please keep the environmental aspects of battery disposal in mind. Batteries must be disposed-of at a battery collection point.

**21.** Use this apparatus in tropical and/or moderate climates.

## LEGAL DISCLAIMER

MUSIC Group accepts no liability for any loss which may be suffered by any person who relies either wholly or in part upon any description, photograph, or statement contained herein. Technical specifications, appearances and other information are subject to change without notice. All trademarks are the property of their respective owners. MIDAS, KLARK TEKNIK, LAB GRUPPEN, LAKE, TANNOY, TURBOSOUND, TC ELECTRONIC, TC HELICON, BEHRINGER and BUGERA are trademarks or registered trademarks of MUSIC Group IP Ltd. © MUSIC Group IP Ltd. 2017 All rights reserved.

---

## LIMITED WARRANTY

For the applicable warranty terms and conditions and additional information regarding MUSIC Group's Limited Warranty, please see complete details online at [music-group.com/warranty](http://music-group.com/warranty).



## 1. Introduction

Thank you for expressing your confidence in us by purchasing the GUITAR LINK UCG102. Your computer will become the ultimate working platform on which you can use the classic effects, in the studio as well as on stage. With a notebook, a guitar and the UCG102, it is now possible to work on the go, be it train or hotel. The GUITAR LINK UCG102's scope of delivery includes a first-class modeling software with virtual amps and effects pedals. Accompany songs in MP3-, WAV- and AIFF-format which you can play from your PC or Mac computer. A headphone connection with a volume regulator is also available so that you can enjoy the session with your favorite volumes undisturbed, entirely after the motto "Plug'n Rock".

### 1.1 Before you get started

#### 1.1.1 Shipment

Your GUITAR LINK UCG102 was carefully packed at the assembly plant to assure secure transport. Should the condition of the cardboard box suggest that damage may have taken place, please inspect the unit immediately and look for physical indications of damage.

- ◆ Damaged equipment should NEVER be sent directly to us. Please inform the dealer from whom you acquired the unit immediately as well as the transportation company from which you took delivery. Otherwise, all claims for replacement/repair may be rendered invalid.
- ◆ Please always use the original packaging to avoid damage due to storage or shipping.
- ◆ Never let unsupervised children play with the device or with its packaging.
- ◆ Please dispose of all packaging materials in an environmentally friendly fashion.

### 1.2 Online registration

Please register your new BEHRINGER equipment right after your purchase by visiting [behringer.com](http://behringer.com) and read the terms and conditions of our warranty carefully.

Should your BEHRINGER product malfunction, it is our intention to have it repaired as quickly as possible. To arrange for warranty service, please contact the BEHRINGER retailer from

whom the equipment was purchased. Should your BEHRINGER dealer not be located in your vicinity, you may directly contact one of our subsidiaries. Corresponding contact information is included in the original equipment packaging (Global Contact Information/European Contact Information). Should your country not be listed, please contact the distributor nearest you. A list of distributors can be found in the support area of our website ([behringer.com](http://behringer.com)).

Registering your purchase and equipment with us helps us process your repair claims more quickly and efficiently.

Thank you for your cooperation!

## 2. Controls and Connections

You can connect the UCG102 directly to an amp by means of the jack connector and to your PC or Mac computer by using the USB connector. The USB connection supplies the power for the UCG102.

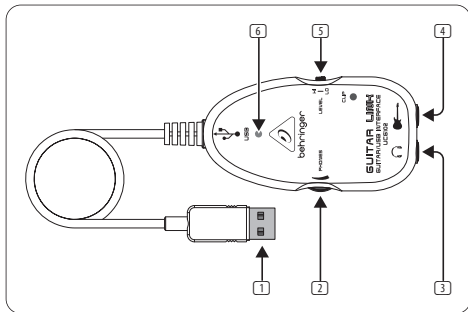



Fig. 2.1: Control elements and connections

- 1 You can connect the guitar to your computer via USB connection. The blue control LED 6 indicates that a connection to the computer has been established.
- 2 The VOLUME control adjusts the volume level of the headphones output. Turn the control fully to the left before you connect the headphones. This helps you avoid the damage that is caused by high volume settings.

- 3 You can use a commercially available ¼" jack for the -connection.

◆ We would like to draw your attention to the fact that extremely loud sound levels may damage your hearing as well as your headphones/loudspeakers. Turn the VOLUME control fully clockwise before you switch on the unit. Be careful to select a suitable volume at all times.

- 4 You can connect the UCG102 to your guitar via the guitar input (¼" jack). Use a commercial ¼" mono jack cable.
- 5 You can modify the guitar signal with the LEVEL switch. At high signal levels, the CLIP LED (above the BEHRINGER LOGO) will light up red in which case you should set the LEVEL switch to LOW.
- 6 The blue LED indicates the status of the USB connection.

### 3. Application Example

You can connect the UCG102 directly to your computer in order to record, play along to a playback or play directly over the modeling amps and effects. The UCG102 lets you get started immediately, wherever you are. Simply hook up and start to rock.

### 3.1 Operation of the connector

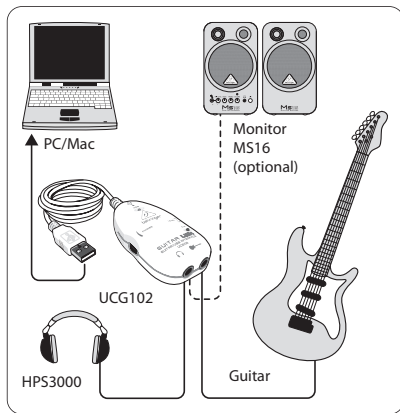



Fig. 3.1: Wiring of the UCG102

Use the USB cable to connect the GUITAR LINK UCG102 to your computer. The USB unit of the UCG102 is bus powered—no separate power supply is needed. The blue LED  lights up and the system indicates the connection of a USB audio unit.



Connect your headphones to the PHONES connector on the UCG102.

If you don't want to use your headphones, you can also connect a pair of active monitors to the PHONES connector—the BEHRINGER MONITOR SPEAKERS Series, MS16, MS20, MS40, B2030A or B2031A are perfect choices for this application.

## 4. Audio Connections

With the integrated USB interface, you can change your computer to an ultimate recording studio. Whether you rehearse at home or in the studio, the used audio connections always remain the same.

### 4.1 Wiring

You connect the UCG102 to your guitar via a standard instrument cable.

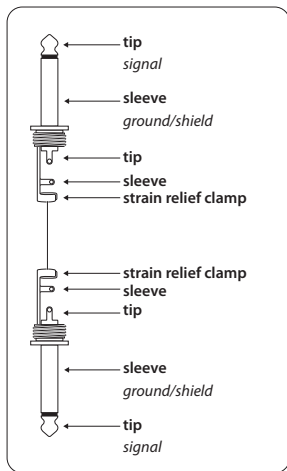

Fig. 4.1: Unbalanced instrument cable with 1/4" TS connector

## EN 4.2 Headphone connection

The UCG102 provides a connection for head-phones. You can connect any standard commercial headphone with a 1/4" TRS jack plug. For mini TRS jack plugs, you will need a suitable adapter. You can see the required pin allocation from the following diagram.

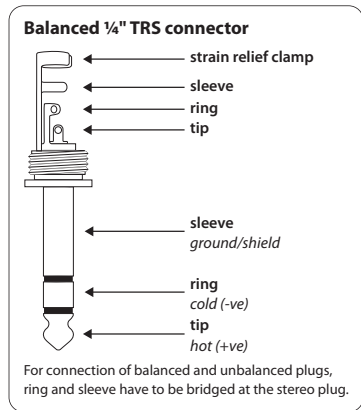

Fig. 4.2: TRS stereo connector

## 4.3 USB cable

The UCG102 comes with a USB cable for connecting USB-compatible devices like notebooks.

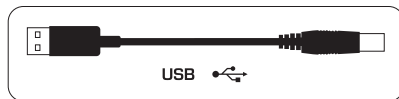

Fig. 4.3: USB connector cable

## 5. Specifications

### Guitar In

Connector	¼" TRS
Input Impedance (High)	250 kΩ
Input Impedance (Low)	400 kΩ

### Phones Out

Connector	¼" TRS
Output impedance	approx. 50 Ω
Max. output pegel	-2 dBu, 2 x 3.7 mW @ 100 Ω

### USB 1.1

Connector	type A
-----------	--------

### Digital Processing

Converter	16-bit converter
Sample rate	32.0 / 44.1 / 48 kHz

### Power Supply

USB connection	5 V $\overline{-}$ , 100 mA max.
----------------	----------------------------------

### Dimensions / Weight

Dimensions (H x W x D)	approx. 1 x 2 x 3 ¾" approx. 24.6 x 50.8 x 95.6 mm
Cable length	approx. 5 ½" / 15 cm
Weight	approx. 0.198 lbs / 0.09 kg

### System Requirements (PC / Mac)

Operating system	Win XP / Win 7 / Win 8 / Win 8.1 / Mac OS X
Processor min. (PC)	Pentium 700 MHz / Athlon XP 1.33 GHz
Processor min. (Mac)	G4 733 MHz / Intel Core Duo 1.66
RAM (PC)	256 MB
RAM (Mac)	512 MB

### Software

Applications	please see “Software Installation Guide”
Driver (Windows)	high-performance driver BEHRINGER USB AUDIO for Win 98 (SE) / ME / 2000 / XP / Vista / Win 7 / Win 8 / Win 8.1
Driver (Mac OS X)	Core Audio

BEHRINGER is constantly striving to maintain the highest professional standards.

As a result of these efforts, modifications may be made from time to time to existing products without prior notice. Specifications and appearance may differ from those listed or illustrated.

## FEDERAL COMMUNICATIONS COMMISSION COMPLIANCE INFORMATION



Responsible Party Name: **MUSIC Group Services NV Inc.**

Address: **5270 Procyon Street  
Las Vegas, NV 89118  
USA**

Phone Number: **+1 702 800 8290**

### **GUITAR LINK UCG102**

complies with the FCC rules as mentioned in the following paragraph:

This equipment has been tested and found to comply with the limits for a Class B digital device, pursuant to part 15 of the FCC Rules. These limits are designed to provide reasonable protection against harmful interference in a residential installation. This equipment generates,

uses and can radiate radio frequency energy and, if not installed and used in accordance with the instructions, may cause harmful interference to radio communications. However, there is no guarantee that interference will not occur in a particular installation. If this equipment does cause harmful interference to radio or television reception, which can be determined by turning the equipment off and on, the user is encouraged to try to correct the interference by one or more of the following measures:

- Reorient or relocate the receiving antenna.
- Increase the separation between the equipment and receiver.
- Connect the equipment into an outlet on a circuit different from that to which the receiver is connected.
- Consult the dealer or an experienced radio/TV technician for help.

This device complies with Part 15 of the FCC rules. Operation is subject to the following two conditions:

- (1) this device may not cause harmful interference, and
- (2) this device must accept any interference received, including interference that may cause undesired operation.

#### **Important information:**

Changes or modifications to the equipment not expressly approved by MUSIC Group can void the user's authority to use the equipment.

Dedicate Your Life to MUSIC

[behringer.com](http://behringer.com)

